

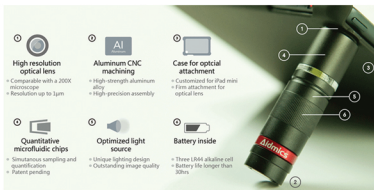

# iSperm with iPad mini, the perfect combination for every vet!



- High resolution optical lens**
  - Compatible with a 200X microscope
  - Resolution up to 1µm
- Aluminum CNC machining**
  - High strength aluminum alloy
  - High precision assembly
- Case for optical attachment**
  - Customized for iPad mini
  - Easy attachment for optical lens
- Quantitative microfluidic chips**
  - Simultaneous sampling and quantification
  - Patent pending
- Optimized light source**
  - Unique lighting design
  - Customized image quality
- Battery inside**
  - Three 18645 alkaline cell
  - Battery life longer than 30hrs



[www.huvesearch.com](http://www.huvesearch.com)

## iSperm

To see is to believe.

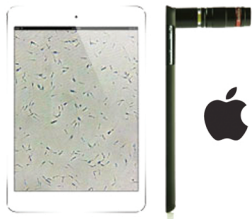

iSperm was developed for every person involved in breeding and who is actively using IA technologies. This tablet (mini-iPad) software with the optical associated kit offers a very quick (<1 min) and precise reading of the concentration, motility and progressive motility.

The analyses, based on a very small (7,5 µl) volume of semen offers an accurate evaluation of the doses quality before proceeding insemination.

It can be used to analyze animal semen with a specific software for each species: equine, porcine, ovine, bovine, canine and poultry.

The extreme portability of the system and the robust design makes it the perfect traveling companion for every veterinary or every actor performing IA.

The data transfer through the connected (iCloud) database allows a very efficient and proactive production handling.

Specifications :

Concentration (range): 20-500 million/ml (relative error ±5%)

Motility: 0-100% (relative error ±5%)

Progressive Motility: 0-100% (relative error ±5%) (available for the most of animal species with a full report of VAP (µm/s), VCL (µm/s), VSL (µm/s), Lin (%), STR (%) and much more...

Testing time: 7 sec video recording and 10 sec automatic analyze

Optical zoom corresponding to a 200X magnification on microscope

Optical resolution: 1-1.5µm

Weight: 350g (without Apple iPad mini)

Battery: LR44 X 3, up to 45 hours of use

Camera 5 MP picture; 1080 p Full HD

**HuVeSearch SPRL**

Europalaan, 11 - BP 12

3900 PELT - Belgium

Tel : 0032 474 988 280

Mail : [contact@huvesearch.com](mailto:contact@huvesearch.com)



**AIDMICS**  
BIOTECHNOLOGY

The power of seeing the unseen

Official Website:

<https://isperm.aidmics.com>

Email:

[service@aidmics.com](mailto:service@aidmics.com)

 iSperm

**iSperm mCASA**

The First Smart Semen Analysis Solution on iPad





## **AIDMICS** BIOTECHNOLOGY

Believing in the power of seeing the unseen, we are devoted to creating mobile solutions for tracking dynamic particles with computer vision technology. Aidmics has the vision of equipping every professional with a modern and quantifiable workflow. iSperm is now one of the leading brands in animal reproductive biology, providing an affordable, transportable yet powerful semen analysis system.



To learn how you can benefit from having the iSperm, please scan the QR code or go to:

<https://isperm.aidmics.com>

# What is iSperm mCASA?



## A Portable Computer for Semen Analysis

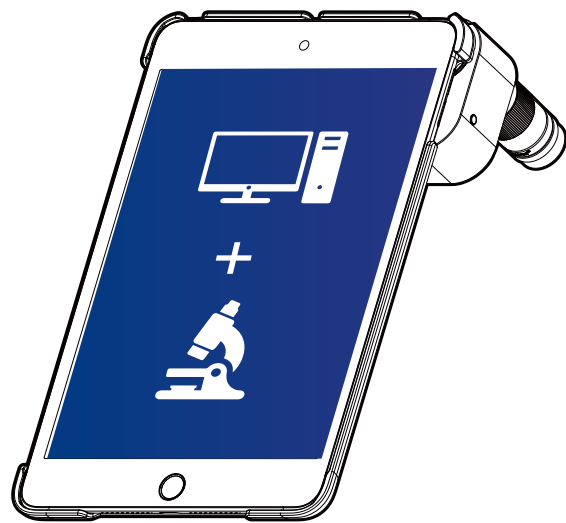

iSperm is the first mini/mobile computer-assisted sperm analyzer (mCASA). It offers readings in terms of concentration, total motility, progressive motility and sperm kinetics. Capable of analyzing semen qualities for various species, iSperm provides the flexibility to be adapted to economic, companion, and endangered animals.

Also, iSperm labels tracks of sperm movements. This feature greatly helps users to clearly understand the behaviors of the sperms, to train new-in colleagues, and to investigate further when unexpected event occurs.

With iSperm, you can monitor the fertility of male animals, provide animal reproduction services, conduct trainings/workshops smarter, easier, and much more efficient.

## Major Values that iSperm mCASA Creates for Theriogenologists



### Applicable in Various Scenarios & across Species

Having to deal with more than one species? Traveling between your labs and the fields is a routine for you? iSperm brings you the highest mobility and flexibility.

With the weight of a laptop and the size of a briefcase, iSperm is a portable and professional computer specialized in semen analysis. It is designed to conduct sperm assessment both in and outside a lab. You can now perform quick-screening in the field, and work on sophisticated examinations in the lab.



### Facilitating Accurate Assessment by Visualizing Sperm Movements

Seeing isn't always believing. Visualizing sperm movements, an exclusive add-on of the iSperm, completes your proficiency. As you know, a moving sperm doesn't guarantee its fertility. Strictly defined criteria have to be met to be called fertile motility-wise. With iSperm, sperms are labeled in various colors according to their swimming tracks. Cross-referencing to the videos with your evaluation, you'll be more comfortable to confirm your diagnostics.



### Collecting Data Now & Getting Insights in the Future

In a breeding management program, data are always the most important source to get insights. It's not just about checking the current status of the fertility of a male animal. It's about a long-term effort to deal with male reproductive issues. iSperm helps you manage it and only requires your extra efforts to the level of almost none.



### Easy & User-friendly

iSperm is not just another hard-to-manage equipment. It brings the best user experience through incorporating modern technology with humanity. The operation steps are made as simple and straightforward as possible. Users only need to take minimum trainings to get the capability of obtaining accurate analysis results. iSperm helps a new-in teammate to pick up research works made previously way easier and faster.



# The Flexibility of iSperm



## Multi-Species in One

The sperm analysis algorithm is developed and fine-tuned exclusively for different species, including equine, bovine, canine, caprine, and porcine. Complying with industrial conventions, each software comes with customized user interface for respective species.

You can install multiple software on one device, and manage data for each species separately. Furthermore, you can also leave notes and calculate doses/straws to be dispensed... all on this one device.



## Applicable in All Environments

With conventional semen analysis systems, mostly only useful in a lab setting, semen should be quickly transported to a lab immediately after its collection. However, for field works conducted in a rural area, sending samples to a lab is difficult, or even unrealistic.

iSperm provides a revolutionary yet practical solution - allowing assessments in the field.

With the same key functions as a desktop CASA system, iSperm satisfies all your needs when doing on-field researches. When all the students are equipped with their own iSperm, teachers are also allowed to develop lectures with hands-on activities in classes.



## Feedback from iSperm Users

Distributed in 18 countries with users from around 40 countries, iSperm has become one of the must-have systems to be equipped with for veterinarians, research institutes, and breeders.

Bovine veterinarians in Australia recognized the usefulness of iSperm when chute-side bull-check has to be implemented off the breeding season. They are so inundated with heavy workload that their pressure would be eased greatly from getting both obtaining and recording data done simultaneously (and the data can be organized and exported merely with a few steps on iSperm Cloud, see p.10). That's exactly the value iSperm could render.

In the US, a wealth of equine vets and clinics acknowledged that they feel safe to be informed with numerical indicators at the frontline after they discovered that the correlation did exist between the reproductive successes and the readings that iSperm offered.

## Social Impacts of iSperm

In Brazil, while Reprocon research group, affiliated to Federal University of Mato Grosso do Sul (UFMS), is working very hard to save wild jaguars from being endangered, iSperm becomes their good friend.

Chester Zoo, one of the must-go zoos in the world, also adopted iSperm to study the infertility issue on their animals. The research activities were documented in a BBC series, *The Secret Life of the Zoo*.

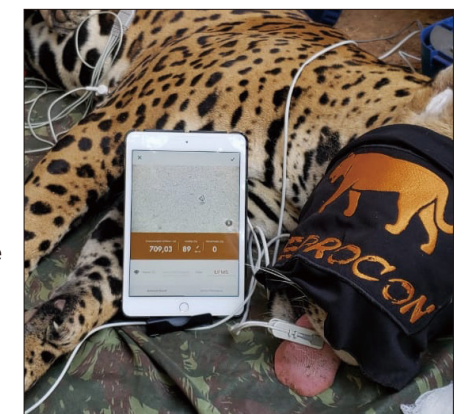

# Visualizing Sperm Movements

As a well-trained professional, manually assessing semen motility may be an easy task for you. What about differentiating the degree of how motile each sperm is? That's exactly when iSperm comes into play.

## Preview:

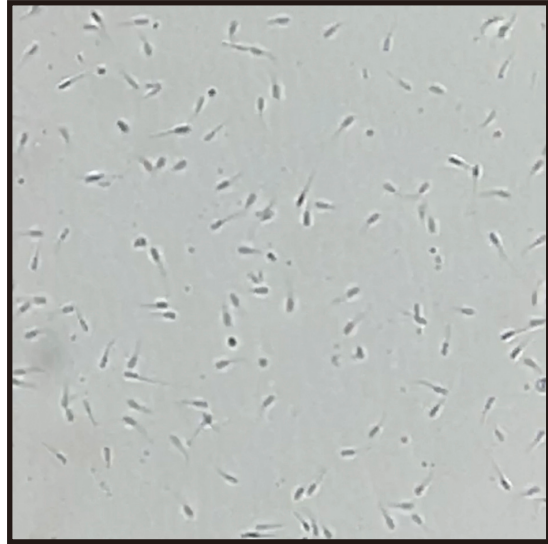

## Tracking:

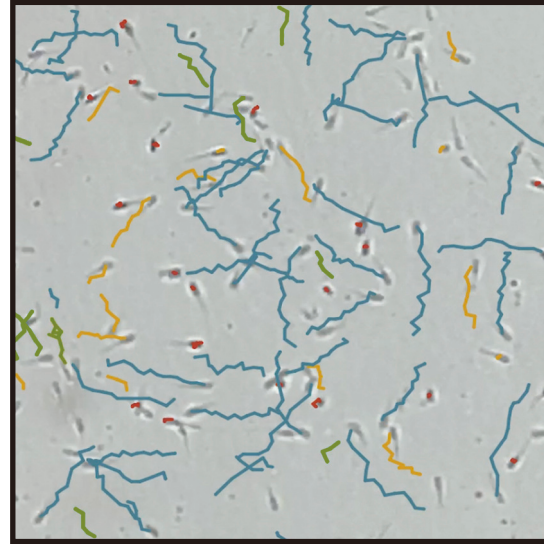

## The value of visualization

Total motility (TM) is one of the most important tests to work on when conducting semen analysis. To successfully swim their way up the female reproductive tract, progressive motility (PM) is needed for the sperms. That means, to run a reproduction program or to preserve a fertile enough semen sample for future use, PM matters.

Nevertheless, sperm cells that swim in a mostly straight line or in very large circles all count as "progressive" by definition. When these different tracks come together, along with those that are defined to be non-progressive, on the same video, your brain may be too overloaded to be able to process them well. Visualization of the tracks along with the PM readings analyzed by iSperm would help you to cross-check the correctness of the readings with your own assessment. It also helps you to setup an objective standard in your clinical practice or hospital for all of your colleagues, for training new-in colleagues, and for showing/explaining to your clients.

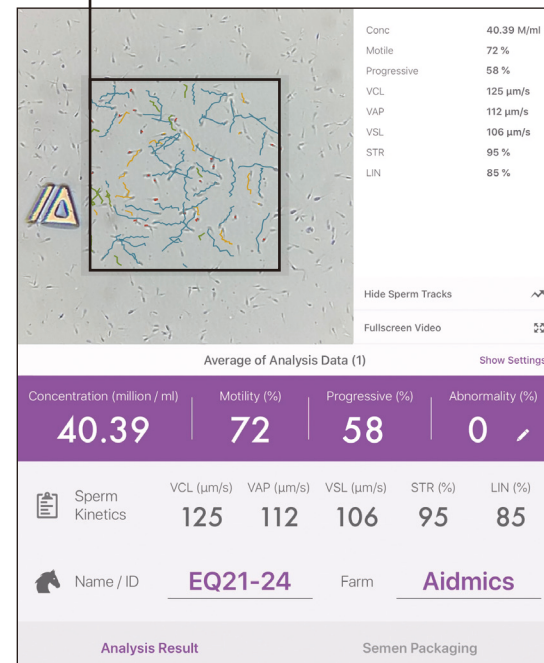

▲ Analysis Result Page

## What iSperm Offers to Make It Possible & Practical

### Sperm tracks are labeled in 4 colors:

- **Progressively motile:**  
The sperm moves forward fast enough and mostly in straight line.
- **Motile:**  
The sperm is moving but isn't progressively motile.
- **Late track:**  
The sperm is not within the area of observation at the beginning, but appears within it somehow in the duration of analysis.
- **Static:**  
The sperm is not moving.

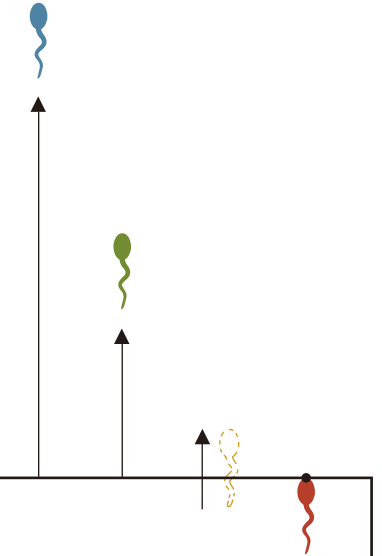

## Motility Readings Are Strictly Defined

Readings for both total and progressive motility are strictly defined by the following kinetic parameters. iSperm makes sure to offer readings that make mathematical sense. This is also the standard a CASA system would benchmark with.

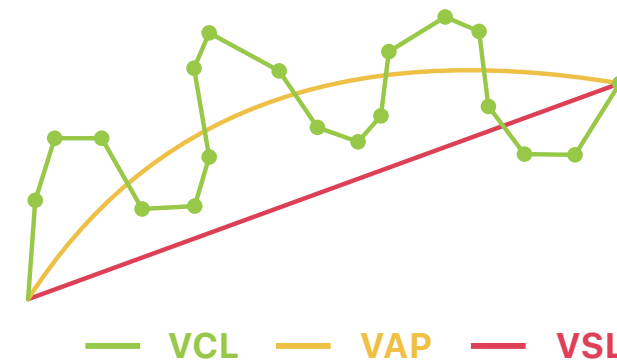

- VCL** Curvilinear Velocity (µm/s)
- VAP** Average Path Velocity (µm/s)
- VSL** Straight Line Velocity (µm/s)
- STR** Straightness (VSL/VAP)
- LIN** Linearity (VSL/VCL)

## Get a Free Demo to Know How Visualization Works

To compare your assessments made with and without visualization, scan the QR code or go to the website for accessing the online resource.



<https://isperm.pse.is/TEWD8>



# Minimum Trainings Are Required

One of the reasons for being unwilling to adopt a new (but useful) tool is having to spend time to command it. This concern isn't applicable on the iSperm. It's designed by eliminating every possible difficulties that a user may struggle with if devised otherwise.

## Mix, Drop, and Cap — Sampling is Done in 3 Steps

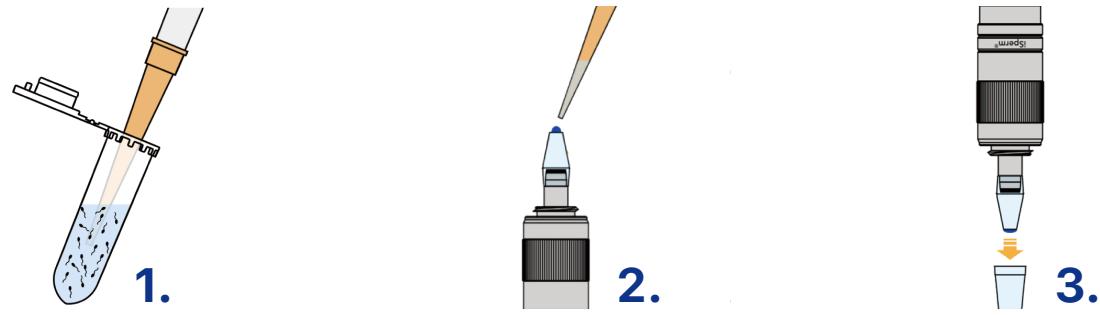

- 1. Mix:** Mixing to-be-observed samples with a pipette/dropper to make sure sperms are evenly distributed.
- 2. Drop:** Aspirating a portion of the well-mixed sample and drop it to a base/cover chip (the consumables) properly with a pipette/dropper.
- 3. Cap:** Install the cover and you're ready to get the analysis done.

*\* When **quick-screening** is needed, to speed up the process, just dip the base chip with the sample and install the cover. (The iSperm Dipping Method)*

## The Lightest Hardware that Requires the Simplest Operation Steps

The hardware is consisted of only the essential parts - the sample collector (for sampling and backlighting samples), the microscopic lens, the heating system, and a tablet. Once the hardware setup is ready in place, the extra effort you'll need to make is to screw the collector onto the lens - perhaps extra more couple of minutes to wait for the heating system to warm up to a desired temperature.

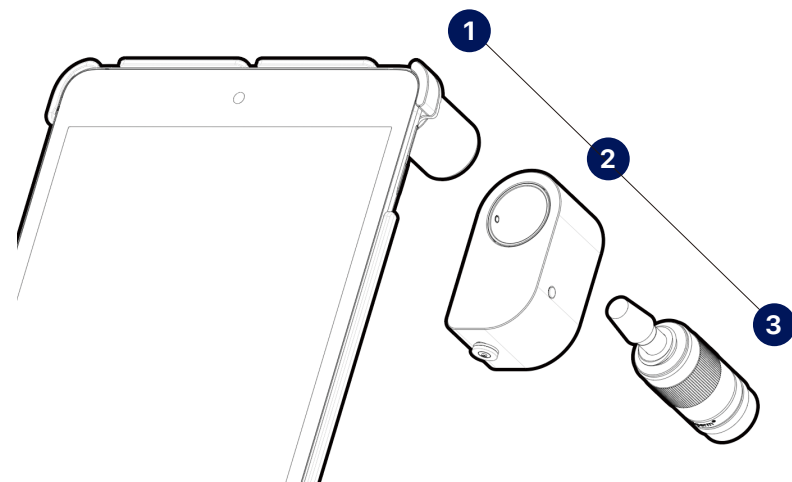

- 1. Install iPad mini & Case**
- 2. Install Heater**
- 3. Install Sample Collector**

*\* No extra focus is needed. Once the sample collector is screwed in place, it's right on focus.*

## Obtain Analytics with Only A Few Taps

With the help of automatic systems geared by programming, you can harvest wanted outcomes with higher convenience - but not necessarily so if the software interface is too complicated to keep up with. iSperm prevents you from experiencing this painful process with its streamlined workflow.



▲ Semen Analysis

▲ Analysis Result

▲ Packaging & Saving

### 1. Semen Analysis

Wait for 10 seconds to be provided with a measurement.

No further human evaluation needed. The program algorithm does the job independently.

### 2. Analysis Result

Be provided with readings along with the movies. Whenever double- or even triple-check is called for, the videos recorded can always be your best traces to investigate.

### 3. Packging & Saving

Key in required info to keep the analyses on record. Data are organized and stored with their matching animal IDs and Farms.

### 4. Data Center

Go to Data Center to review history of specific animals or farms/clients. Recorded data can be sorted in desired formats. Monitoring reproductive performance of each male animal or farmland is then possible.

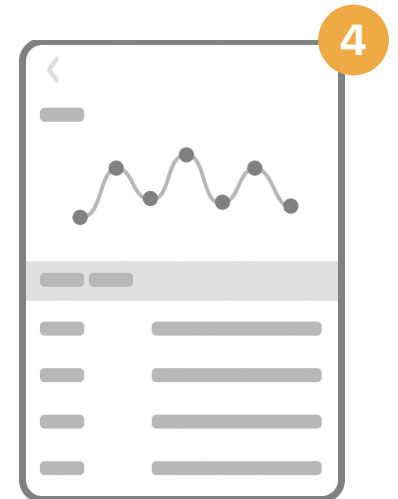

▲ Data Center

# Real-Time Process & Access of the Data

## Semen Packaging: iSperm Does the Math for You

Are you looking for an efficient way to know how many portions of semen you can dispense with, and keep the desired records for review later at the same time? iSperm would be your most ideal solution. Just right after you fill in the blank columns, you'll be provided with info of how much volume of extender needed, and how many straws/doses you can dilute the raw semen into. This one further step only takes you seconds. In return, you'll take advantage of being able to monitor male fertility with this extra vital piece of information.

Raw Concentration (million / ml)	Measured Concentration (million / ml)	Total Motility (%)	Progressive Motility (%)
201.94	40.39	72 <small>Abnormality = 0%</small>	58
Dilution Ratio, Semen : Extender = 1 : 4 (Raw concentration is used for calculation.)			
Volume	40	ml	
Desired Extended Concentration	50	million / ml	
Volume Per Dose	10	ml	
Target Number of Sperms Per Dose	0.2	billion / dose	
Calculate with: <input type="checkbox"/> Motile Sperms <input checked="" type="checkbox"/> Progressive Sperms			
Notes (input some additional information here)			
EQ21-24 (Aidmics) Total sperms = 8.1 billion Number of doses = 16			
Raw Semen	Extender	Total Motile Sperms	
2.5 ml / dose	7.5 ml / dose	0.3 billion / dose	
Analysis Result		Semen Packaging	



## Your Data Can Always Be within Your Reach

You might have had this moment. When you urgently needed a data set for further assessment or research, you realized that these data were saved and only accessible in your lab while you were actually in your house. By connecting your iSperm to wifi, all the stored data sets will be uploaded to your iSperm Cloud automatically. You can access these data whenever and wherever you are.

### 1 Graphs & Charts

iSperm automatically generates graphs and charts for you. You can then explore insights for a specific animal or farm through these visualized display of data.

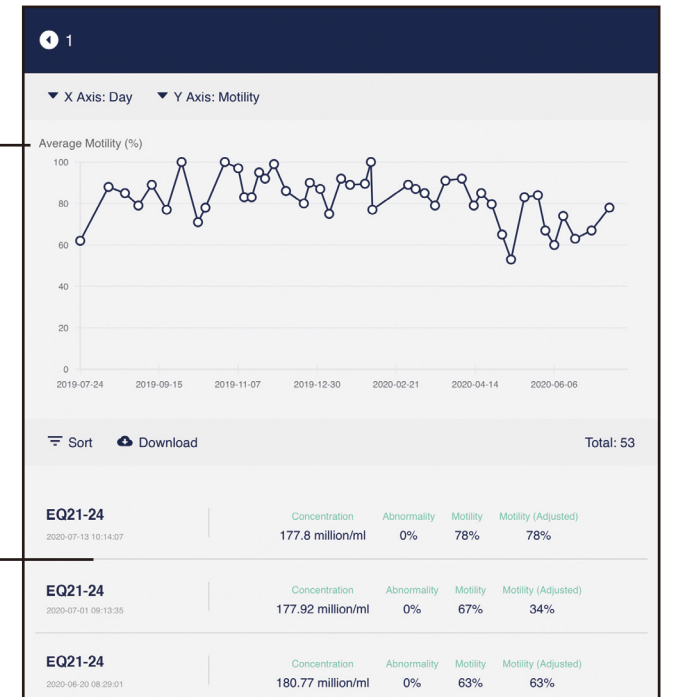

### 2 Downloadable Data in Editable Format

To integrate with data collected from other systems or to be organized for use in an academic publication, you can export the data in an editable format.

### 3 Video Export

Retrieving videos directly from the device along with their corresponding analytics can be completed at your fingertips.

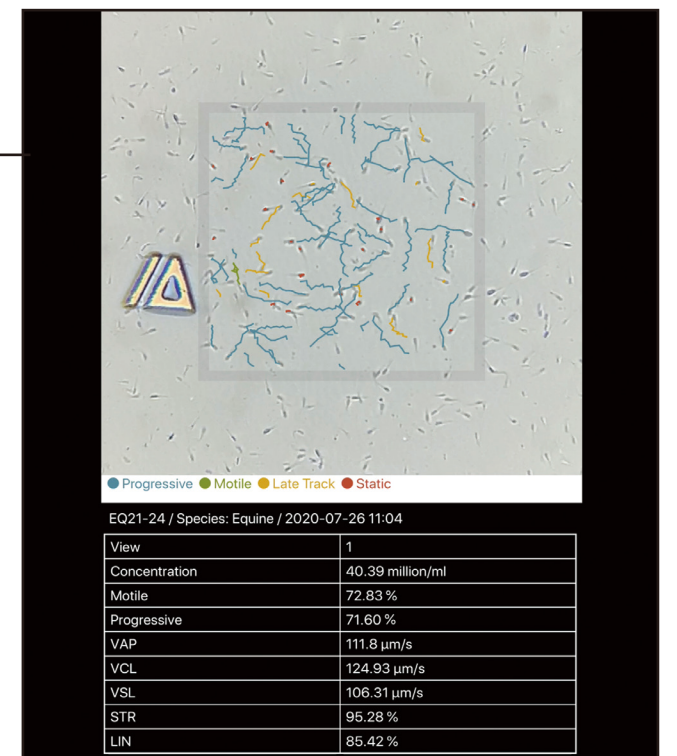



# Verified Accuracy

The accuracy of iSperm is comparable to standard semen analysis systems.

## Concentration Validation: iSperm vs. Nucleocounter & Hemocytometer

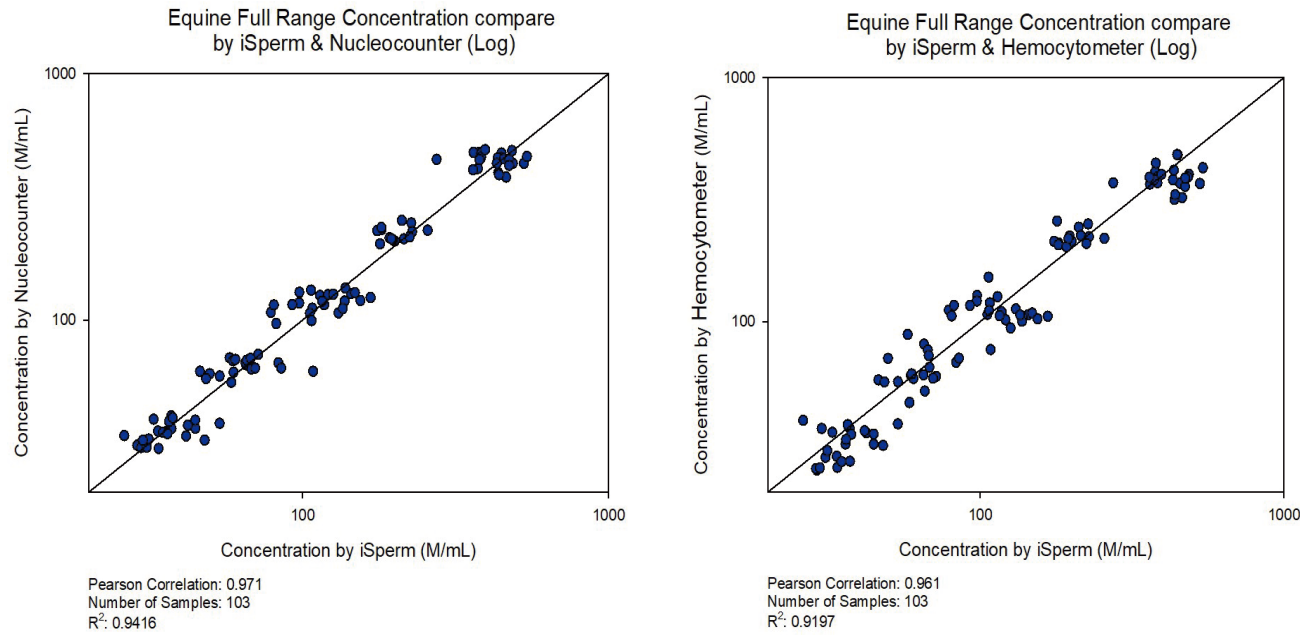

## Motility Validation: iSperm vs. CASA Systems - Hamilton Thorne

The motility is compared at concentration of 20-60M/ml.

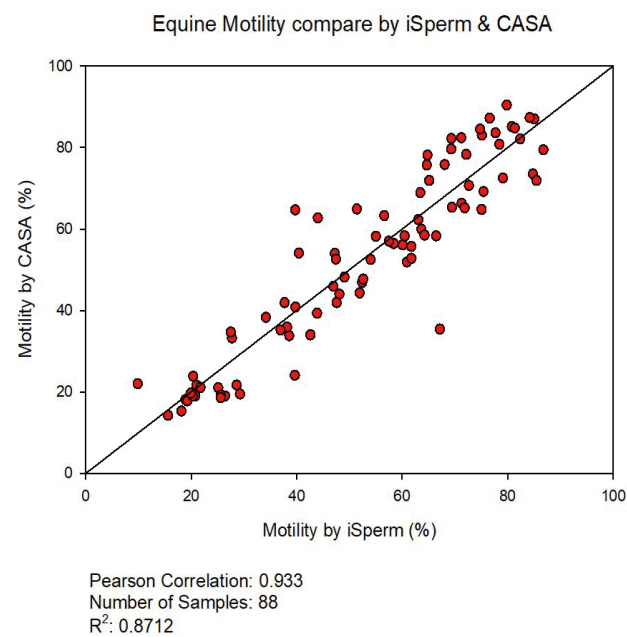

## Third Party Verifications



*Theriogenology Laboratory, College of Veterinary Medicine, The Ohio State University, USA*

**Technical Note: The use of iSperm technology for on-farm measurement of equine sperm motility and concentration**  
Translational Animal Science

*Veterinary Medicine, Ghent University, Belgium*

**Validation of a portable device (iSperm®) for the assessment of stallion sperm motility and concentration**  
Reproduction in Domestic Animals, Wiley

*Department of Anatomy, Physiology, and Cell Biology, School of Veterinary Medicine, University of California, Davis, CA and Guide Dogs for the Blind, San Rafael, California, USA*

**Assessment of an iPad-based Sperm Motility Analyzer for Determination of Canine Sperm Motility (Tentative title)**  
(Manuscript in Preparation)

## Certificates



USA - FDA Establishment Registration and Device Listing with US Food & Drug Administration

Japan - Certified Veterinary Medical Devices by Ministry of Agriculture, Forestry and Fisheries (MAFF)

Scan the QR code to stay tuned with iSperm:



<https://isperm.aidmics.com>